

OPERATING INSTRUCTION MANUAL
FOR THE
MODEL LM-510
LIQUID CRYOGEN
LEVEL MONITOR



CRYOMAGNETICS, INC.
INNOVATIVE TOOLS FOR SCIENTIFIC RESEARCH

1006 Alvin Weinberg Drive
Oak Ridge, Tennessee 37830
Phone: (865) 482-9551 Fax: (865) 483-1253
Web: <http://www.cryomagnetics.com>

WARNING!
DO NOT ATTEMPT TO OPERATE THIS EQUIPMENT BEFORE YOU
HAVE THOROUGHLY READ THIS INSTRUCTION MANUAL.

CE

MANUFACTURER'S DECLARATION OF CONFORMITY

According to ISO / IEC Guide 22 and EN45014

Manufacturer's Name: Cryomagnetics, Inc.

Manufacturer's Address: 1006 Alvin Weinberg Drive
Oak Ridge, TN 37830

Declares. the product

Product Name: Liquid Cryogen Level Monitor
Model Number: LM-510
Product Options: All Options

Conforms to the following Product Specifications:

Safety: EN61010-1 (95)
EN61326-1 (97)

EMC: EN61326-1 (97) Electrical Equipment for Measurement,
Control and Lab use – EMC Requirements
EN61000-4-2 (95) Electrostatic Discharge Immunity Test
EN61000-4-3 (96) Radiated Electromagnetic Fields
EN61000-4-4 (95) Electrical Fast Transient/Burst
EN61000-4-5 (95) Amendment A-Surge Immunity Test
EN61000-4-6 (96) Amendment A-Immunity to Conducted
Disturbances
EN61000-4-11 (94) Voltage Dips, Short Interruptions and
Voltage Variations

Application of Council Directives:

The product complies with the requirements of the Low Voltage Directive
73/23/EEC as amended by 93/68/EEC and the EMC Directive 89/336/EEC as
amended by 93/68/EEC.

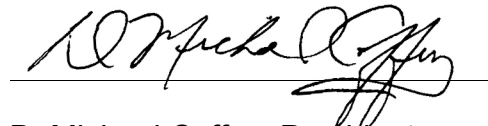

D. Michael Coffey, President
Cryomagnetics, Inc
Oak Ridge Tennessee August 22, 2012

TABLE OF CONTENTS

1.0	Introduction	1
1.1	Specifications	3
2.0	Factory Calibrations, Installed Options and Certification	5
3.0	Instrument Setup and Sensor Connection	7
3.1	Line Voltage and Fuse.....	7
3.2	Connecting Sensors, Relay Functions and Analog Outputs	7
4.0	Operation and Menus.....	11
4.1	Menu Organization	12
4.2	Liquid Helium Level Channel.....	14
4.2.1	Mode	14
4.2.2	Alarm Set Points.....	14
4.2.3	Control Mode.....	15
4.2.4	Units	15
4.2.5	Boost	15
4.2.6	Sensor Active Length	15
4.2.7	Lead Resistance.....	16
4.2.8	Ohms per CM.....	16
4.3	Liquid Nitrogen (Capacitance) Level Channel.....	16
4.3.1	Alarm Set Points.....	16
4.2.2	Control Mode.....	17
4.2.3	Units	17
4.2.4	Sensor Active Length	17
4.2.5	Offset / Gain	18
5.0	Control Interfacing.....	19
5.1	Analog Output.....	19
5.2	Automatic Refill.....	19
5.3	Using Ctrl as an Alarm.....	22
6.0	Theory of Operation	23
6.1	Liquid Helium Level Sensing (Superconductive Filament Probes).....	23
6.2	Liquid Nitrogen Level Sensing (Capacitive Probes)	24
6.3	LM-510 Circuit Description	25
7.0	Limited Warranty Policy	27

List of Figures and Tables

Figure 3.1 - LHe Level Sensor Connector Wiring	7
Figure 3.2 - LN2 Sensor Connector Wiring.....	8
Figure 3.3 - Auxiliary Connector Wiring (DB-9F)	9
Figure 4.1 - Typical LM-510 Display (with Two Channel Option)	11
Figure 4.2 - LM-510 Menu Hierarchy.....	13
Figure 5.1 - Typical Automatic Cryogen Refill System	20
Table - LM-510 Commands	<i>(Appendix A - p. 32)</i>

Appendix A	Computer Interface Command Reference	29
Appendix B	Line Voltage Controller Module - Option 4	46
Appendix C	Factory Calibration / Firmware Updates.....	47

1.0 Introduction

The LM-510 Liquid Cryogen Level Monitor is the most advanced instrument for monitoring and controlling cryogenic liquids available today. Its versatile architecture allows configuration to virtually any cryogenic fluid including liquid helium, liquid nitrogen, LNG, LOX and many others.

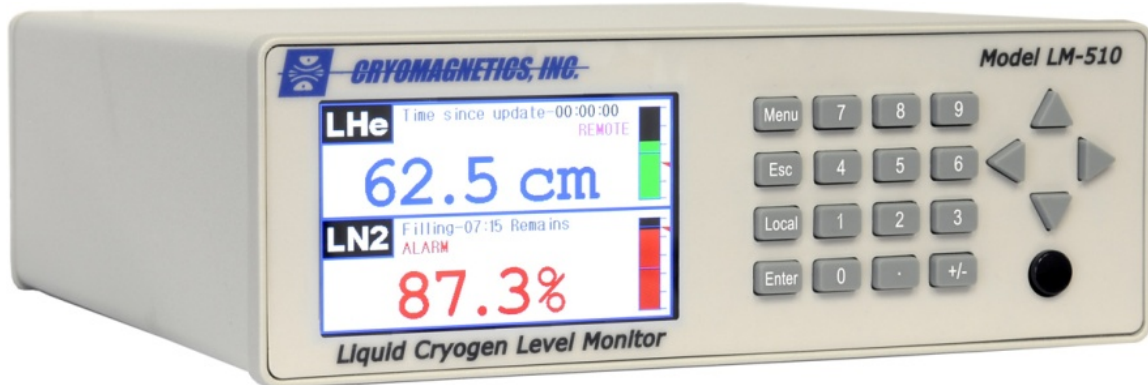

The LM-510 is available in single channel or two-channel versions. With the two-channel option the instrument has two independent input channels that are factory configurable to either the same or different liquid types. The unit is compatible with liquid helium level sensors based upon industry standard niobium-titanium superconducting elements. Virtually all liquid helium sensor manufacturers use this technology, so the LM-510 can be used with most existing equipment. Flexible calibration procedures allow the use of two, three, or four wire configured liquid helium sensors.

Capacitive sensors are used to monitor liquid nitrogen, LNG and other cryogenic fluids. As with liquid helium sensors, the LM-510 can monitor many manufacturers' capacitive sensors due to advanced circuit design.

The LM-510 has user-adjustable high and low set points that may be used to control automated refill cycles. With the two-channel option, independent set points can be adjusted for each channel. This allows simultaneous control of two liquid cryogen systems with a single LM-510.

Also included are fully adjustable alarms for each channel. Most commonly set below the low control set point, the alarm can be used to alert the user (audibly and visually) to a problem with the refill cycle, and to automatically take action (relay contacts are provided).

Unique features of the LM-510 include a sensor deicing cycle and filament burnout protection for liquid helium systems. This insures reliable, accurate level readings even under the most adverse cryogenic conditions.

Computer control of the LM-510 is possible via USB and Ethernet interfaces – both are provided in the standard configuration. IEEE-488 and RS-232 interfaces are available as options. LabVIEW® virtual instrument drivers are available to allow computer control via a familiar, intuitive interface. A wide variety of other options are also available that allow the instrument to be upgraded and tailored to your particular requirements.

Specifications

Common Specifications

Display Update Rate:	~ 500ms Intervals
Control/ Alarm Relay Voltage Rating	100V
Control/ Alarm Relay Current Rating	135mA
12V Loop Source	25mA maximum
4-20mA Analog Output Loop Power	24V maximum
0-10V Analog Output	1 mA maximum
AC Input:	100-240V a.c., 50-60 Hz, 30 Watts
Operating Temperature:	15 °C to 35 °C
Relative Humidity	10% to 95%, non-condensing
Overall Dimensions:	185 mm W X 67 mm H X 197 mm D
Weight:	1.0 kg
USB interface:	USB 1.1/2.0 Full-Speed
IEEE-488 interface:	IEEE-488.2-1992 Standard
Ethernet:	IEEE-802.3 10/100 BASE-T

Liquid Helium Channel Specifications

Maximum Sensor Length:	200 cm
Measurement Resolution	0.1 cm or 0.1 percent of sensor length
Measurement Accuracy	+/- 0.5% FS

Liquid Nitrogen Channel Specifications

Maximum Sensor Capacitance:	2000 picofarads
Measurement Resolution	0.1 cm or 0.1 percent of sensor length
Measurement Accuracy	+/- 1.0% of calibrated range

Model Configurations

LM-510-10	Single Channel Liquid Helium
LM-510-11	Dual Channel Liquid Helium
LM-510-20	Single Channel Liquid Nitrogen
LM-510-22	Dual Channel Liquid Nitrogen
LM-510-12	Dual Channel Liquid Helium/Liquid Nitrogen

Optional Equipment

LM-510-xx-1	IEEE-488 Interface
LM-510-xx-2	RS-232 Interface
LM-510-xx-3	19" Rack Mountable Cabinet
LM-510-xx-4	Line Voltage Controller Output

The LM-510 is designed to operate per the specifications in this table and the instructions provided in this manual. Other use may impair the safety protections provided by the equipment.

This Page Intentionally Left Blank

2.0 Factory Calibrations, Installed Options and Certification

LM-510 Serial Number: _____

Input Channel 1:

Type: LHe _____ LN2 _____ Other: _____
Calibration: Sensor Manufacturer / Serial No: _____
Sensor Length: _____
Characteristic Resistance/Voltage: _____
Lead Resistance: _____

Input Channel 2: Not Installed: _____

Type: LHe _____ LN2 _____ Other: _____
Calibration: Sensor Manufacturer / Serial No: _____
Sensor Length: _____
Characteristic Resistance/Voltage: _____
Lead Resistance: _____

Computer Interface Installed: IEEE-488.2 (Option 1) : _____ RS-232(Option 2): _____

Notes: _____

Certified: _____

Date: _____

This Page Intentionally Left Blank

3.0 Instrument Setup and Sensor Connection

The LM-510 is delivered to you fully tested and ready to operate. This includes sensor calibration if Cryomagnetics supplied the sensor(s) with the instrument. Calibration will also be complete if the active sensing length of an existing sensor(s) was specified at the time of order.

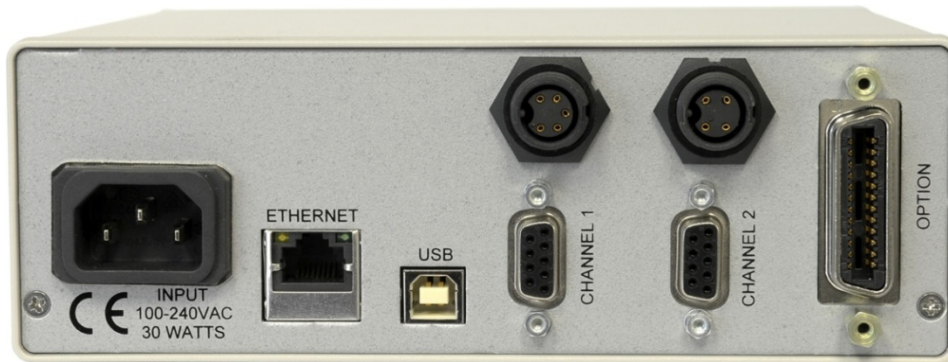

3.1 Line Voltage and Fuse

The LM-510 is designed to operate with any AC power source between 100V and 240V A.C. and 50 to 60 Hz. No user serviceable fuse is provided.

3.2 Connecting Sensors, Relay functions, and Analog Outputs

Sensors connect to the LM-510 at the rear panel using circular connectors located above the labels 'Channel 1' and 'Channel 2'. Figure 3.1 indicates the pin designations for the Liquid Helium Sensor connectors.

Figure 3.1 - LHe Level Sensor Connector Wiring

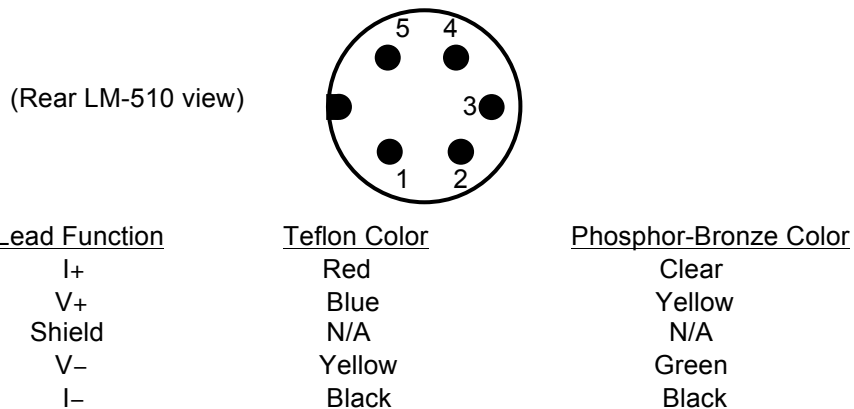

The Liquid Nitrogen Level sensor connections are shown in Figure 3.2.

Figure 3.2 - LN2 Level Sensor Connector Wiring

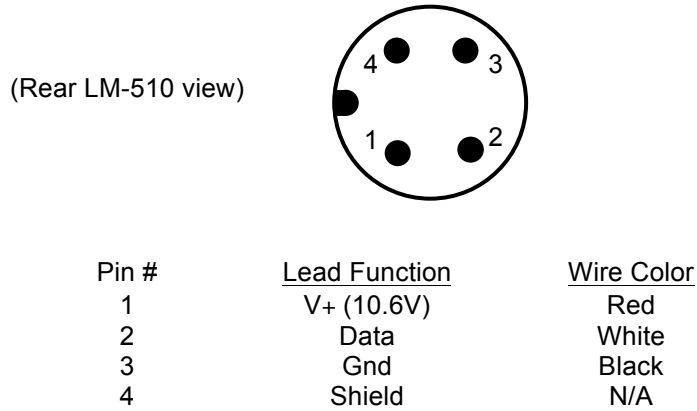

******* IMPORTANT *******

1) Connections should NEVER be made directly to the connector on the rear panel. Always solder to a mating connector that is not attached to the unit. Connections should be double-checked for accuracy prior to attaching to the LM-510 and powering the unit ON since liquid helium level sensors are driven by high voltages (up to 70 volts DC). These high voltages could damage liquid nitrogen sensors or other sensors (such as temperature sensors or hall probes) should these be accidentally connected.

2) NEVER connect/disconnect the sensors with the LM-510 powered ON.

.....

Each input channel of the LM-510 also has a dedicated auxiliary DB-9F connector. This connector provides access to the automatic refill (control) relay and alarm relay functions, the 4-20mA analog output signal, and the 0-10V analog output signal. There is also a 12V output that may be used to power the 4-20mA analog output current loop. Figure 3.2 indicates the pin designations for the auxiliary connector.

Figure 3.3 - Auxiliary Connector Wiring - DB-9F

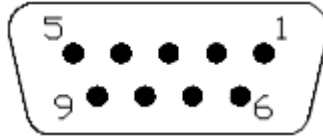

View Facing Rear Panel Connector

Pin #	Function:	Pin #	Function:
1	Control Relay – Contact A (NO)	6	Control Relay – Contact B (NO)
2	Alarm Relay – Contact A (NO)	7	Alarm Relay – Contact B (NO)
3	0-10V Analog Output	8	4-20mA Loop Power In
4	4-20mA Analog Output	9	12V Loop Power Out (25mA max)
5	Analog Ground		

Cryomagnetics' liquid helium level sensors have four (4) lead wires and use either #30 AWG Teflon insulated lead wires or color coded phosphor-bronze lead wires (either option may be specified when the sensor is ordered). The connector pin connections and standard color codes for lead wires are shown in Figure 3.2.

Some liquid helium level sensors made by Cryomagnetics may have only 2 or 3 lead wires. If the sensor has 3 lead wires, the I- and V- leads are typically combined into a single black lead. If the sensor has 2 lead wires, the I- and V- leads are combined into a single black lead and the V+ lead is not used. The V+ connection at the input to the LM-510 should be connected to the I+ terminal in this case.

Cabling between the liquid helium level sensor and the LM-510 should be of appropriate size such that high voltage drop across the I+ and I- leads does not occur. It is recommended that cables up to 5 meters in length be #18 AWG wire minimum. Cables from 5 to 15 meters in length should be #16 AWG minimum, and cables from 15 to 30 meters should be #14 AWG minimum. Unshielded cable may be used where no significant use of SCR-controlled equipment or intense electrostatic field sources are present. Otherwise, it is recommended that shielded cable be used.

This Page Intentionally Left Blank

4.0 Operation and Menus

Setup of the LM-510 can be performed either through the front panel keypad and simple menu instructions or through remote computer interface (USB, Ethernet or IEEE-488.2). Sensor set up and calibration is only supported through the front panel keypad. The following sections contain detailed descriptions of how to set up different sensor types and lengths, adjust alarms, and configure the controller functions.

Before connecting any level sensors or other cabling to the LM-510, connect the power cord provided with your LM-510 to an appropriate power source. Power the instrument ON and familiarize yourself with the display. If your LM-510 is configured for dual sensor inputs, the top half of the display will indicate Sensor #1 and the bottom half will indicate Sensor #2. If your LM-510 is configured for a single sensor input, the display will only indicate one level.

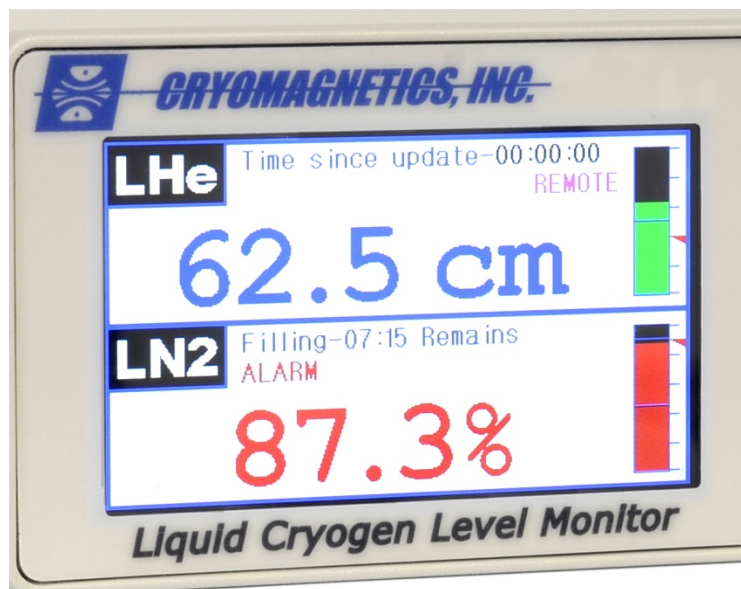

Figure 4.1
Typical Model LM-510 Display (with Two Channel Option)

To the right of the liquid level reading is a bar-graph indication of liquid level. The bar-graph is color coded to give a quick visual indication of system status.

The bar graph has two horizontal blue lines that indicate the automatic control set points that have been entered. So for instance if you want to configure the LM-510 to automatically refill a cryostat when the liquid level drops to 10% and turn off the fill when it reaches 90%, these values can be set

in the “Ctrl Low” and “Ctrl High” menu settings. Horizontal blue lines on the bar-graph show these set points.

Similarly alarm high and low set points may be entered in the LM-510. These set points are shown on the bar-graph with a red caret symbol. Setting the high alarm at 100% and the low alarm at 0% removes the caret symbol from the display.

A liquid helium level channel may indicate "Open Sensor" or "Burnout Protect" instead of a level. Open sensor is self-explanatory. If no sensor is attached to the LM-510 or if a connection is broken the unit will display the error message and will disable the output to prevent high voltages from being present on the sensor wires. If the LM-510 is in Continuous mode, the sensor will be reactivated every 10 seconds to see if the connection has been fixed. If the LM-510 is in Sample-and-Hold mode, the sensor will be reactivated at the normal sample interval.

Burnout Protect is displayed if the LM-510 detects a sensor resistance runaway condition (a resistance more than 130% of the expected resistance of the sensor in gas and at room temperature). This condition may occur if the user attempts to activate the sensor while it is in a vacuum. Burnout protect is activated to reduce the chance of damaging the sensor. If Burnout Protect is activated, the sensor will be deactivated and the error message displayed. As with Open Sensor described above, if the LM-510 is in Continuous mode, the sensor will be reactivated every 30 seconds to see if the condition has been resolved. If the LM-510 is in Sample-and-Hold mode, the sensor will be reactivated at the normal sample interval.

If the LM-510 is operating in sample/hold mode with a liquid helium level sensor, the top line of the display will show a timer that indicates how long ago the displayed reading was taken. The interval between readings may be adjusted (see section 4.2.1 below). If the user wants to update the display without changing the sample interval, simply press <ENTER> and the instrument will take new liquid helium level readings.

4.1 Menu Organization

The menus of the LM-510 are designed to minimize the number of keystrokes required, while at the same time being intuitive for system operators. The level monitor menu options are accessed by pressing the “Menu” button on the keypad and using the ◀▶ keys to highlight the desired channel tab. General instrument setup options are accessed by highlighting the Setup tab.

Figure 4.2 – LM-510 Menu Hierarchy

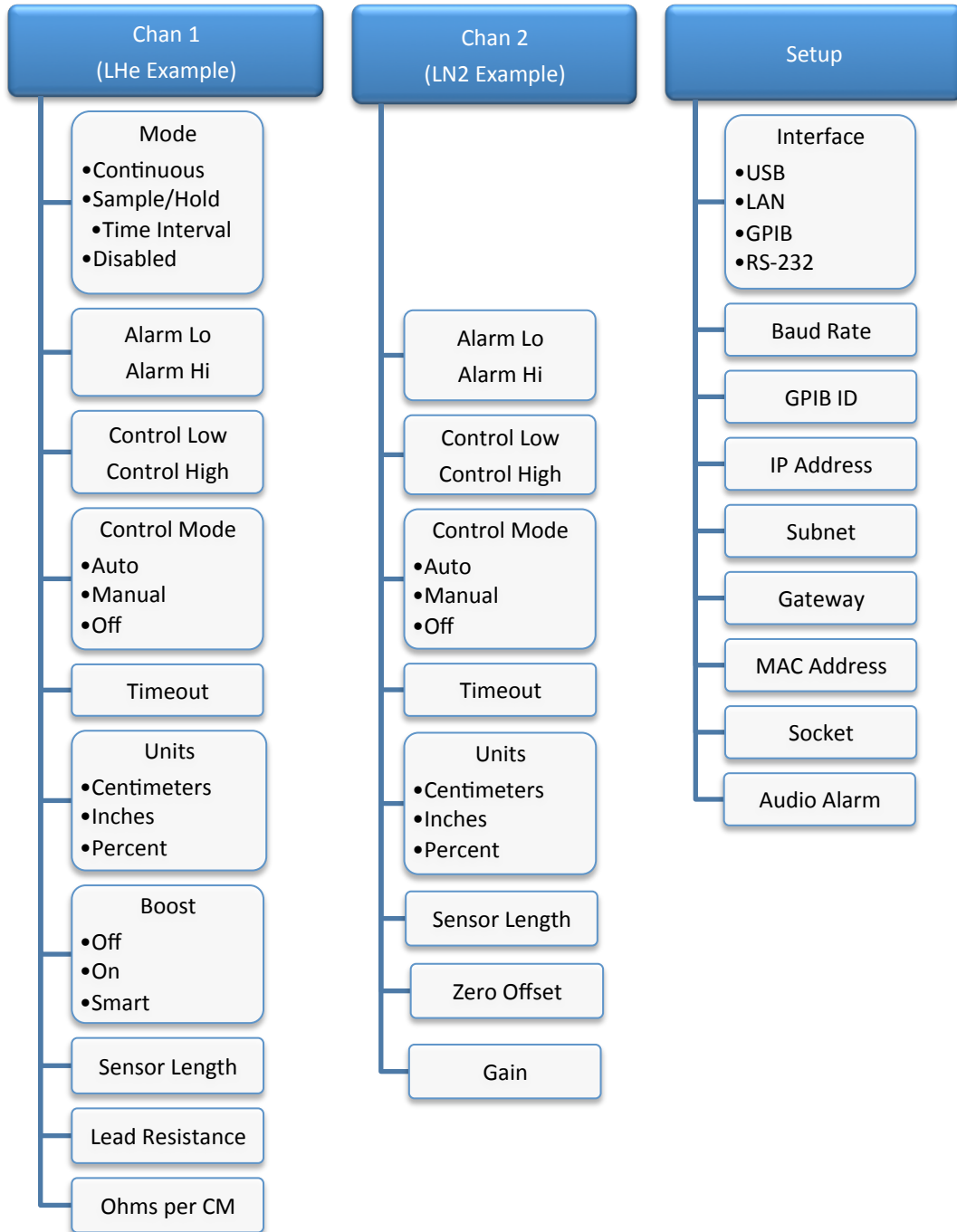

4.2 Liquid Helium Level Channel

To set up a liquid helium level sensor, power ON the LM-510 and press the MENU key. Use the ◀▶ keys to select the appropriate sensor channel tab at the top of the display, then the ▲▼ keys to select the sensor parameter to be calibrated. There are several user-adjustable options available for liquid helium level monitoring. The above diagram indicates options and the menu headings under which they are found. A description of the menu items is outlined below.

Figure 4.3 – Liquid Helium Channel Menu

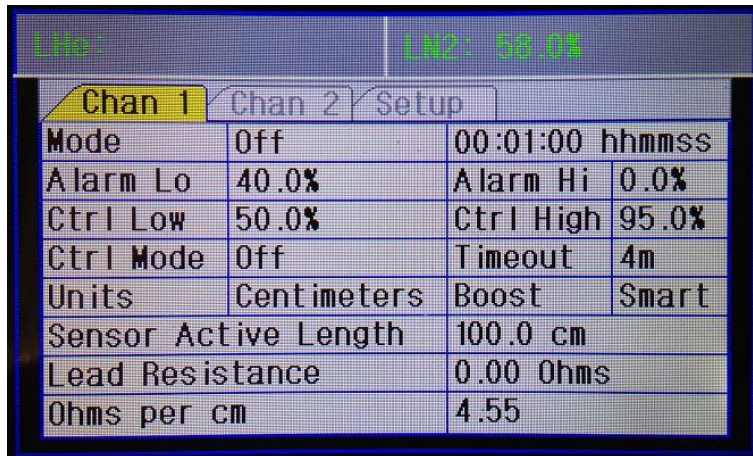

LN2: 58.0%		
Chan 1	Chan 2	Setup
Mode	Off	00:01:00 h:mm:ss
Alarm Lo	40.0%	Alarm Hi 0.0%
Ctrl Low	50.0%	Ctrl High 95.0%
Ctrl Mode	Off	Timeout 4m
Units	Centimeters	Boost Smart
Sensor Active Length		100.0 cm
Lead Resistance		0.00 Ohms
Ohms per cm		4.55

4.2.1 Mode

In the Mode menu item the user can select Sample/Hold, Continuous or Off. This item appears first in the menu list since it may be changed frequently in a system that is left in Sample/Hold mode normally, but is switched to Continuous mode during liquid helium refills. Pressing ENTER while “Mode” is selected toggles the unit between Sample/Hold, Continuous, and Off modes. The display will indicate the selected mode.

While in Sample/Hold mode, an interval of time between readings of the liquid helium level sensor in Sample/Hold mode can be specified. With Sample/Hold selected, press ▶ or ▼ to highlight the interval setting display. Then use the keypad keys to enter the sample interval to the desired time in hours, minutes, and seconds, separating each with a “.” (decimal point).

4.2.2 Alarm Set Points

The LM-510 has alarm set points that may be used to alert the operator when the LHe level falls

below a user-settable threshold or exceeds a high alarm level. The set points for the high and low alarms (entered in %) are set in the “Alarm Lo” and “Alarm Hi” fields in the LM-510 Menu. Separate set points are available for each channel if the two channel option is installed.

The alarm function gives a front panel display indication when activated and an audible alarm will sound if enabled in the Setup Menu. The audible alarm can be silenced by pressing any front panel key on the LM-510; however, the visual indication of the alarm condition is maintained until the liquid level is read by the LM-510 and is found to be above the alarm level set point.

If the low alarm is set to 0% or the high alarm is set to 100%, the associated alarm is disabled. If both the high and low alarms are enabled, the alarm will be active if the liquid level is below the low alarm or above the high alarm set points.

4.2.3 Control Mode

The LM-510 includes control capabilities that can be configured in the main menu for each channel. Menu settings related to control are Ctrl Lo, Ctrl High, Ctrl Mode, and Timeout. Control settings are used to activate or deactivate the Control Relay outputs for each channel (see Figure 3.2) and to give a visual indication on the display. See Section 5 for details on setting up an automatic control (auto-refill) system and for information about using the Ctrl functions as an alarm.

4.2.4 Units

The Units menu item allows the user to set the display units of the LM-510 for this particular channel. Available options are percent (%), centimeters (cm), or inches (in). Note that sensor lengths (see Sect. 4.1.6 below) must be entered in centimeters.

4.2.5 Boost

The “Boost” menu item allows the user to set the sensor de-ice mode of the LM-510 on this particular channel according to the system’s requirements. Options under this item are:

OFF Current to the sensor is never boosted to a higher setting to clear contaminants on the sensing filament.

ON Current to the sensor is briefly boosted to a higher setting at the beginning of each liquid level reading to clear contaminants on the sensing filament.

SMART Current to the sensor is only boosted to a higher setting at the beginning of a liquid level reading to clear contaminants if the sensor has not been activated within the past five minutes of operation.

4.2.6 Sensor Active Length

The "Sensor active length" should be set to the actual length of the sensing filament in the sensor. This is usually the overall length of the sensor less any dead space on the ends of the sensor. Cryomagnetics' sensors typically have 1 cm of dead space on each end. Sensor lengths up to 200.0 cm may be set.

4.2.7 Lead Resistance

The "Lead resistance" should be set to zero if a standard 4-wire sensor is being used. If a 2 or 3 wire sensor is being used, the resistance of the leads can be entered and will be removed from the sensed value. For a 2-wire sensor the lead resistance will be the measured resistance from the I+/V+ lead to the I-/V- lead, less the resistance of the active sensing filament ($4.55 \text{ ohms/cm} \times \text{active sensing length in cm}$ for Cryomagnetics' sensors). For a 3-wire sensor the lead resistance will usually be the measured value of resistance between the V+ lead and the I- lead, less the resistance of the active sensing filament, divided by two (since you only need to subtract out the lead resistance of the I- lead, not both the I- and V+ leads). To change the lead resistance setting, use the keypad keys to adjust the value. Press ENTER to accept and save the value, or ESC to exit without saving.

4.2.8 Ohms per CM

The "Ohms per cm" field is the characteristic resistance of the sensor. Use the characteristic resistance at 20K, not at room temperature. Cryomagnetics' sensors typically have a characteristic resistance at room temperature of about 5.46 ohms/cm and 4.55 ohms/cm at 20 Kelvin.

When finished entering the sensor calibration data, press MENU and ENTER to accept and save the displayed value or ESC to exit without saving the changes.

4.3 Liquid Nitrogen (Capacitive) Level Channel

To set up an LN2 sensor, power ON the LM-510 and press the Menu key. Use the ◀▶ keys to

select the appropriate sensor channel tab at the top of the display, then the ▲ ▼ keys to select the sensor parameter to be calibrated.

There are several user-adjustable options available in the LM-510 for liquid nitrogen or other cryogenic fluid level monitoring and control. A description of the menu items is outlined below.

Figure 4.4 – Liquid Nitrogen Channel Menu

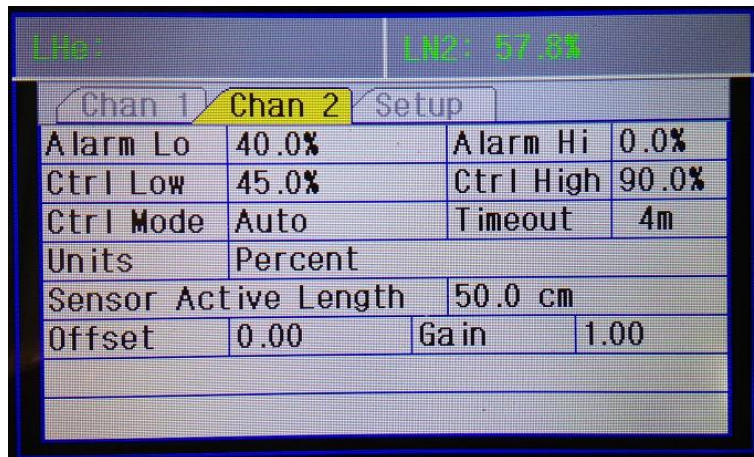

LN2: 57.8%			
Chan 1	Chan 2	Setup	
Alarm Lo	40.0%	Alarm Hi	0.0%
Ctrl Low	45.0%	Ctrl High	90.0%
Ctrl Mode	Auto	Timeout	4m
Units	Percent		
Sensor Active Length	50.0 cm		
Offset	0.00	Gain	1.00

4.3.1 Alarm Set Points

The LM-510 has alarm set points that may be used to alert the operator when the LN2 level falls below a user-settable threshold or exceeds a high alarm level. The set points for the high and low alarms (entered in %) are set in the “Alarm Lo” and “Alarm Hi” fields in the LM-510 Menu. Separate set points are available for each channel if the two channel option is installed.

The alarm function gives a front panel display indication when activated and an audible alarm will sound. The audible alarm can be silenced by pressing any front panel key on the LM-510; however, the visual indication of the alarm condition is maintained until the liquid level is read by the LM-510 and is found to be above the alarm level set point.

If the low alarm is set to 0% or the high alarm is set to 100%, the associated alarm is disabled. If both the high and low alarms are enabled, the alarm will be active if the liquid level is below the low alarm or above the high alarm set points.

4.3.2 Control Mode

The LM-510 includes control capabilities that can be configured in the main menu for each channel.

Menu settings related to control are Ctrl Lo, Ctrl High, Ctrl Mode, and Timeout.

Control settings are used to activate or deactivate the Control Relay outputs for each channel (see Figure 3.2) and to give a visual indication on the display. See Section 5 for details on setting up an automatic control (auto-refill) system and for information about using the Control functions as an alarm.

When configured for auto-refill a fill cycle may be initiated manually by selecting 'Manual' for the 'Control Mode' setting. When the manual fill cycle completes it will transition to 'Off'.

4.3.3 Units

The Units menu item allows the user to set the display units of the LM-510 for this particular channel. Available options are percent (%), centimeters (cm), or inches (in). Note that sensor lengths (see Sect. 4.2.5 below) must be entered in centimeters.

4.3.4 Sensor Active Length

Liquid nitrogen sensors are set up through the LM-510 menu in a manner that is similar to liquid helium level sensors. In the "Sensor Active Length" field, the user should enter the active sensing length of the LN2 sensor. (Note that LN2 sensors, due to their capacitive nature, do not have a standard characteristic value. So in fact the sensor active length that is entered is somewhat arbitrary.)

4.3.5 Offset / Gain

The Offset / Gain settings of the LM-510 allow the user to make manual calibration adjustments of the LN2 channel independent of liquid level on the sensor. In general the user should initially set the offset to 0.0 and the gain to 1.0. With the sensor's active sensing length entered as described in 4.2.4 above, put the sensor in the cold cryostat but with no liquid on it. Note any zero offset in the displayed reading. If, for instance, the display indicates 0.3 cm of liquid but you know the level is really 0.0 cm, then enter "-0.3" in the Offset field.

Adjustments made to the Gain are used to set the high end of the sensor calibration. After setting the Offset as described above, put a known amount of liquid on the sensor. For example, if you have a 60.0 cm long sensor and you completely cover it with liquid, but the display only reads 59.2 cm, then the Gain should be set to $60.0/59.2 = 1.0135$.

The LM-510 automatically calibrates the analog outputs (4-20mA and 0-10V) based on the display of the instrument. So using the Offset and Gain settings to calibrate the display will also calibrate the analog outputs.

4.4 Setup Menu

The LM-510 has numerous general setup parameters that may be configured in the Setup tab.

Figure 4.5 – Setup Menu

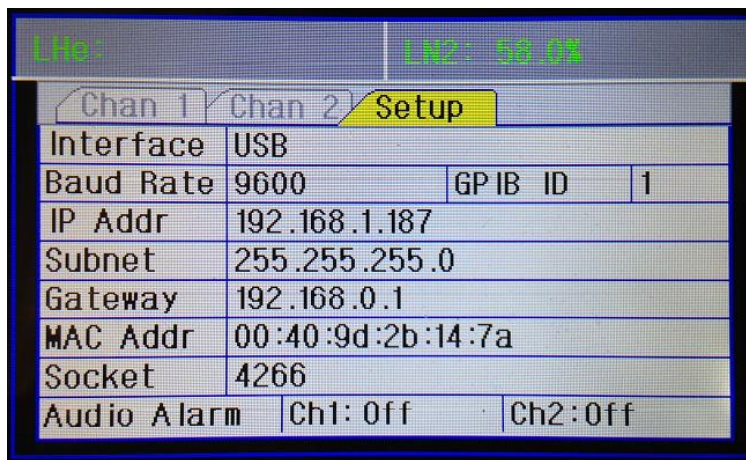

The screenshot shows the Setup Menu of the LM-510 instrument. At the top, there are two status indicators: 'LN1:' and 'LN2: 58.0%'. Below these are three tabs: 'Chan 1', 'Chan 2', and 'Setup', with 'Setup' being the active tab. The main menu area contains the following parameters and values:

Interface	USB		
Baud Rate	9600	GPIB ID	1
IP Addr	192.168.1.187		
Subnet	255.255.255.0		
Gateway	192.168.0.1		
MAC Addr	00:40:9d:2b:14:7a		
Socket	4266		
Audio Alarm	Ch1: Off	Ch2: Off	

The user may select which type of interface is used for communication with the LM-510. USB and LAN (Ethernet) interfaces are standard with all instruments. GPIB (IEEE-488.2) and RS-232 interfaces are optional. To select which interface is active, select the Interface in the Setup tab and press <ENTER> to toggle through the options. Note that per IEEE-488.2 specifications, after selecting the GPIB interface power to the LM-510 must be cycled before the interface will become active.

Other settings that are adjustable in the Setup menu include baud rate for RS-232, GPIB ID, and IP address, subnet mask, gateway and socket (port) for LAN communications. The MAC address is also shown in this menu but is not user-configurable.

For detailed information concerning communicating with the LM-510, refer to Appendix A, the Computer Interface Command Reference section of this manual.

The audible alarm(s) for the LM-510 may also be disabled or enabled in the Setup menu.

4.5 Advanced Menu – Firmware Updates and LN2 Sensor Configuration

The LM-510 has a hidden menus for updating the front panel and channel card firmware and also is used for configuring LN2 sensors. The menu is accessed by entering the last seven digits of the main Cryomagnetics phone number (4829551) and pressing the <Menu> button while the main operating display is active.

4.5.1 LN2 Sensor Configuration Menu

The LN2 Sensor is a smart sensor that retains its own calibration values. It is calibrated using one of two methods. The preferred method is to perform a zero calibration when the sensor is installed, cold, and the LN2 level empty, and a full calibration performed when the LN2 reservoir is known to be full. This will provide the best possible calibration. After this calibration is done the gain should be set to one and offset set to zero in the main LN2 menu. The alternate approach is to enter sensor overall length and active length in this menu, and select Send Values in Cal Action. This approach will require gain and offset to be adjusted in the main LN2 menu for calibration.

Figure 4.6 – LN2 Sensor Configuration Menu

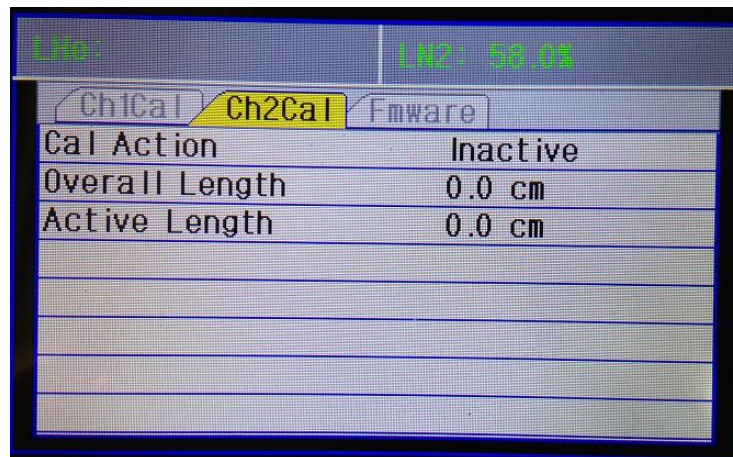

Use the arrow keys to highlight the Cal Action field and press <Enter> until the desired action is shown, then press <Esc> to initiate the action. A prompt will be issued to confirm the operation. If the alternate calibration is being performed, the cable must be disconnected at the sensor and the center conductor and shield of the cable shorted together before sending values. Values for Overall Length and Active Length must be entered before Send Values is selected.

4.5.2 Firmware Update Display

The LM-510 has several processors. The Ethernet module is the starting point for loading new instrument firmware. The version identifiers of the installed firmware and version numbers of firmware loaded into the Ethernet module are shown on this display. The user will be prompted to install firmware updates when different firmware is loaded and this display is accessed. Refer to Appendix C for detailed instructions.

Figure 4.7 – Firmware Update Display

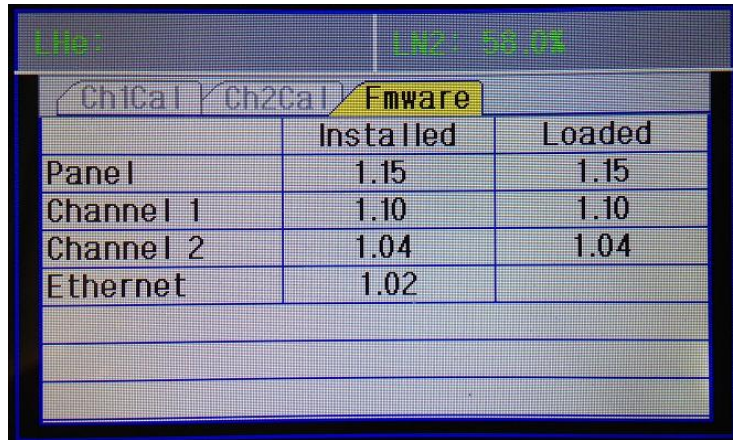

	Installed	Loaded
Panel	1.15	1.15
Channel 1	1.10	1.10
Channel 2	1.04	1.04
Ethernet	1.02	

This Page Intentionally Left Blank

5.0 Control Interfacing

5.1 Analog Output

Each sensor channel on the LM-510 includes both 4-20mA and 0-10V analog outputs. The signals are accessed through the DB-15F connector on the LM-510 rear panel (see Figure 3.1). Analog output signals are linear and proportional to the sensor reading.

5.2 Automatic Refill

The LM-510 in its standard configuration is capable of controlling an automatic liquid cryogen refill system. Since many different types of valves, transfer lines and cryogen handling systems are possible, additional interfaces are necessary to implement a refill system. Figure 5.2 shows a typical automatic liquid cryogen refill system. Note that the system consists not only of the LM-510, but also a Line Voltage Controller Module (Option 4), a cryogen transfer line, a solenoid valve, the level sensor, and any additional venting/plumbing needed to handle off-gas.

In an automatic refill system, the LM-510 monitors the cryogen liquid level in the cryostat. If that level falls below the "Ctrl Lo" set point, the LM-510 activates the Control Relay output (see Figure 3.2) which opens a vent valve on the cryostat and a solenoid valve on the storage dewar transfer line. This begins a liquid cryogen transfer.

The LM-510 Control Relay remains activated (relay contacts closed, holding the valves open) until the liquid cryogen level in the cryostat has risen above the "Ctrl High" set point. At that time the Control Relay is deactivated (relay contacts open), which closes both valves.

Thus the LM-510 maintains the liquid level between minimum and maximum levels. An auxiliary "Timeout" may be set in the menu to abort cryogen transfers that run longer than the operator feels is appropriate. The feature helps minimize overflow of a system having an error in its calibration or prevention of transferring warm gas for lengthy periods of time in the event that the source dewar empties before the high limit is reached.

The LM-510 "Ctrl Mode" may be set to Auto, Manual or Off. A fill cycle may be initiated manually by selecting 'Manual' for the control mode setting. When the manual fill cycle completes the Ctrl Mode will transition to 'Off'.

Figure 5.1
Typical Automatic Cryogen Refill System

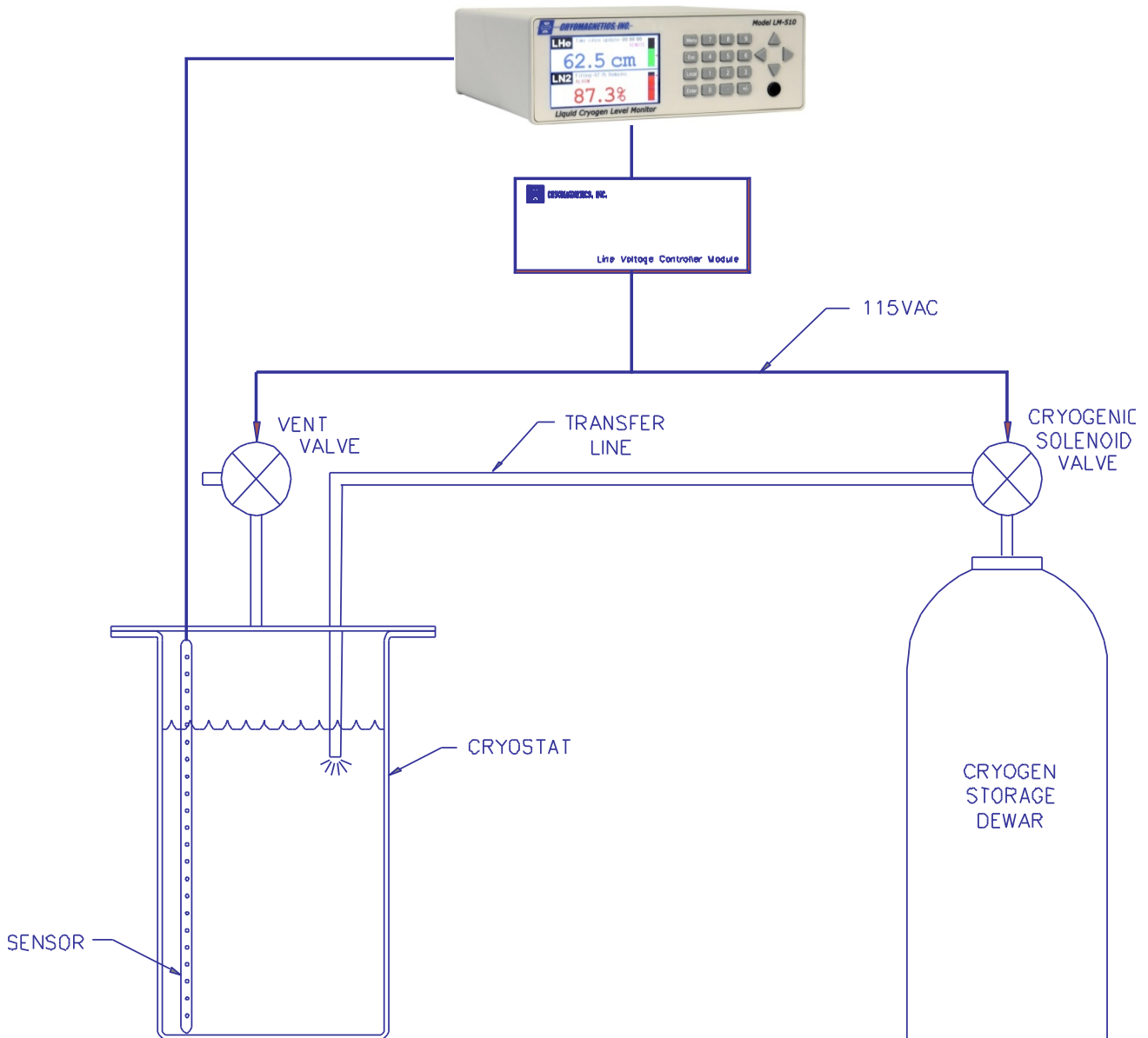

If your LM-510 has the two channel option installed, two totally independent cryogenic systems can be under automatic refill control by a single LM-510.

It is important to note the control relay's voltage and current ratings (see Page 3, Specifications). The relay is not designed to directly drive solenoid valves typically used in automatic refill systems.

When the LM-510 is used in conjunction with Option 4, the Line Voltage Controller Module, as shown in Figure 5.2, the unit is capable of driving solenoid valves requiring 115V/230V AC. Option 4 provides the user with two independent channels with fused and relay-isolated line voltage outputs. Refer to Appendix B for a technical description of Option 4.

In order for the automatic refill to operate properly, several precautions should be taken in setting up the system:

- The cryogen storage dewar should have a regulated pressure maintained which is compatible with the cryogenic solenoid valve, transfer line, cryostat and any equipment installed within the cryostat (such as a superconducting magnet or a variable temperature insert). For most systems, the cryogen storage dewar should be held at about 2-3 PSI above the pressure in the cryostat. If the cryogen storage dewar has a very high pressure inside when the refill cycle is begun, some system components could be damaged by the surge in pressure that occurs when transfer is begun.
- The vent valve in some systems can be bypassed if there is adequate venting available from the cryostat through other pressure relief valves. Again, care should be taken that venting through a fixed pressure relief valve does not cause excessively high back pressure in the cryostat. Also, when an automatic refill cycle is completed, one must be sure the cryostat is sealed properly with appropriate and working pressure relief valves. Refill cycles usually result in significant frost at the vent port of the cryostat. This can frequently result in a pop-off valve becoming frozen in the open position and may allow air or water to be drawn into the cryostat resulting in damage.
- If the wiring between the LM-510, line voltage controller module, valves, and/or sensors is long and in an electrically noisy environment, false signals can be picked up by the LM-510 causing a spurious refill cycle to start. In general, any cabling over 5 meters long should be shielded cables to avoid this problem, although even shorter cables may require shielded lines in some cases.
- The control output(s) of the LM-510 may be disabled by setting the control mode to Off.
- The Timeout setting of the LM-510 should be set to a value which the user is confident is beyond the time needed for a worst-case cryogen transfer, but no further. Should the cryogen storage dewar run out of liquid during a refill cycle, this feature will stop the transfer rather than let it run all night long blowing warm gas into the cryostat.

5.3 Using Ctrl as an Alarm

By setting Ctrl Low setting to 0%, the low level control is disabled. Likewise by setting Ctrl High setting to 100% the high level control is disabled. Doing either of these effectively will give the user the ability to set another alert or alarm level in the LM-510 with an associated relay contact.

For instance, by setting the Ctrl High to 100% (disabling it) and the Ctrl Low to 20%, the user will be alerted on the display when the liquid cryogen level drops to 20%. The Control Relay contacts on the rear panel of the LM-510 can be used to automatically activate the discharge of a superconducting magnet in response to the low level.

6.0 Theory of Operation

Depending upon how your LM-510 is configured, it may be compatible with superconductive filament liquid helium level sensors, capacitive sensors used for liquid nitrogen, LNG, etc., or a combination of the two. It can be configured for single sensor input or dual sensor inputs. Since liquid helium level sensors and capacitive sensors operate on completely different principles, the unit must be factory configured to the options chosen. Changing the sensor configuration of an LM-510 from LHe to LN₂ sensor inputs or vice versa is possible by returning the unit to Cryomagnetics. Consult the factory if this is necessary.

6.1 Liquid Helium Level Sensing (Superconductive Filament Probes)

If at least one input of the LM-510 is configured for liquid helium level sensors, the unit may be used with 2, 3 or 4 wire superconductive filament level sensors for monitoring liquid helium (an industry standard). These sensors use a single filament of NbTi as the level-sensing element. The sensor has a small heater installed near the top of the filament. When a current is passed from I+ to I-, that

is, through the heater and superconductive filament, the top of the filament is forced into the resistive state by the heater. The normal zone of the filament propagates down the length of the filament until it encounters the liquid helium surface. Unable to propagate through the liquid, the normal zone stops. By activating the sensors with a constant current, the voltage measured across the filament is proportional to the length of filament that is in the helium gas. The portion of the filament in the liquid remains superconducting, and therefore has no voltage developed across it. The LM-510 measures the voltage across the filament and converts it, according to the instrument's calibration, into a liquid level which is then displayed.

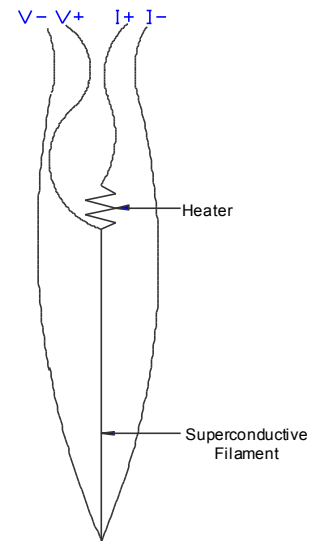

Sensors operating in a 3-wire configuration typically combine the leads I- and V- into a single lead. Doing so adds some lead resistance to the liquid level measurement that would show up as errors in the reading in most helium level monitors. The LM-510, however, has provisions for subtracting out lead resistance in 3-wire sensing systems.

Likewise, sensors operating with only 2 wires combine I+/V+ into a single lead, and I-/V- into a single lead. Therefore two wire sensors have not only the resistive error induced by two leads,

but also the error induced by the heater in the sensor. The LM-510 can easily subtract out all of these errors to give a stable, accurate reading of liquid helium level.

The LM-510 contains circuitry allowing it to sample a liquid helium level sensor at a predetermined interval or on demand. Sampling the liquid helium level minimizes the amount of heat input to the cryogenic system through the sensor - thereby minimizing cryogen boil-off. During a sampling period, the helium level sensor is activated only long enough to obtain a valid reading of the helium level. The sensor is then turned off and the instrument display is updated and held until the next sample time. The LM-510 configured for liquid helium level monitoring also provides a unique sensor deicing cycle within the sensor-reading period. Deicing, which may be necessary if the liquid helium environment has become corrupt from impurities, prevents false readings of liquid level should the sensing filament become contaminated with ice. During the de-ice portion of the sensor sampling, the sensor's current is briefly pulsed to a higher than normal level to clear any ice blockages which may have formed on the sensing filament. This insures an accurate reading of the liquid level even when refilling the cryostat. The sensor deicing part of the sampling cycle can be disabled if desired.

6.2 Liquid Nitrogen Level Sensing (Capacitive Probes)

Capacitive sensors are typically based upon a sensing element comprised of two parallel conductors (usually concentric stainless steel tubes) separated by a space which is open to the cryogenic fluid. The sensor uses the difference in dielectric constant between the liquid and gas phases of the fluid to determine the liquid level. Sensors made by some manufacturers use a tuned oscillator to determine the capacitance of the probe. The oscillator's frequency is converted to a DC voltage which is sent back to the display instrument. Older Cryomagnetics capacitive sensors operated in this way.

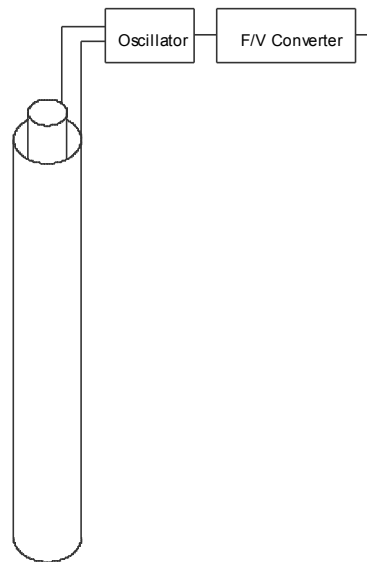

The LM-510 is compatible with both older style sensors and Cryomagnetics' new smart LN2 sensors (the LM-510 will auto-detect which type is attached). Smart LN2 sensors communicate with the LM-510 using a half-duplex serial protocol that is immune to noise and cable length issues.

Calibration of liquid nitrogen level sensors with the LM-510 is performed as described in section 4.2.5 above. In addition, calibration of Cryomagnetics' Smart LN2 sensors can be performed

through the front panel keypad of the LM-510. Calibration cannot be performed through the LM-510 computer interfaces. Please contact Cryomagetics for assistance if you believe re-calibration of your smart LN2 sensor is required.

6.3 LM-510 Circuit Description

The LM-510 is primarily based on Cypress PSoC5 and PSoC3 microprocessor technology. These state of the art devices contain configurable digital and analog circuitry as well as microprocessors that have built-in FLASH and EEPROM memory used to hold factory calibration and configuration data, as well as user entered calibration and setup information. Also included is an Ethernet interface module that enables firmware updates for all the onboard processors to be easily and reliably installed in the field. The LM-510's display is a bright 240x400 TFT LCD unit having high contrast and a wide viewing angle.

The front panel PSoC5 processor controls the display, keypad, and user communication interfaces. It also controls PSoC3 based channel cards that provide sensor excitation, monitoring, analog outputs, and control and alarm relay outputs. Due to the flexibility and stability of the LM-510's circuits, very high resolution and accuracy is achieved. The instrument also provides a card slot for an optional GPIB or RS232 interface.

In units configured for use as liquid helium level monitors, high voltages are possible in the LHe interface cards. Typically, helium level sensors will have characteristic resistances of the sensing element of about 4.5 ohms/cm and optimally run at about 70 mA. The DC-DC converter on the card generates up to 70 volts depending on the length of the sensor. Great care must be taken to avoid shock if any changes are being made inside the unit.

This Page Intentionally Left Blank

7.0 Limited Warranty Policy

Cryomagnetics, Inc. warrants its products to be free from defects in materials and workmanship. This warranty shall be effective for one (1) year after the date of shipment from Cryomagnetics. Cryomagnetics reserves the right to elect to repair, replace, or give credit for the purchase price of any product subject to warranty adjustment. Return of all products for warranty adjustment shall be FOB Oak Ridge, TN, and must have prior authorization for such return from an authorized Cryomagnetics, Inc. representative.

This warranty shall not apply to any product which has been determined by Cryomagnetics, Inc. inspection to have become defective due to abuse, mishandling, accident, alteration, improper installation or other causes. Cryomagnetics, Inc. products are designed for use by knowledgeable, competent technical personnel.

In any event, the liability of Cryomagnetics, Inc. is strictly limited to the purchase price of the equipment supplied by Cryomagnetics, Inc. Cryomagnetics, Inc. shall not assume liability for any consequential damages associated with use or misuse of its equipment.

This Page Intentionally Left Blank

Appendix A

Computer Interface Command Reference

Front panel functions of the LM-510 may be accessed using command strings over the selected computer interface. The following sections detail available commands and required syntax.

The commands available through USB and LAN (Ethernet) are identical to those available through IEEE-488.2; however, some commands may be IEEE-488.2 specific and may not provide responses consistent with the USB and LAN interfaces. The command set includes Local, Remote, and RWLock which are not applicable to IEEE-488.2.

Command strings are normally limited to 120 characters when the USB and Ethernet interfaces are used. A <RETURN> will be generated internally when any line longer than the maximum is encountered, and any valid commands in the received line prior to the internally generated <RETURN> will be processed. All remote commands are case insensitive, allowing upper or lower case to be used without affecting operation of the commands.

When the USB interface is selected, all commands sent to the instrument will be echoed including the terminating ASCII <RETURN> character, followed by a <NEWLINE> character when command processing is complete.

LAN (Ethernet) Interface

The LAN interface is implemented using sockets for remote commands and status. Network parameters are configured in the "SETUP" menu. Commands and responses are formatted the same as for GPIB and USB. LabVIEW and Hyperterminal are convenient tools for using this interface.

USB Interface

The USB port is accessed through the USB Type B connector on the rear panel of the instrument. To use the USB interface, you must install a virtual com port on the PC, which then treats the USB interface as a traditional RS-232 interface. The virtual com port driver is available from Cryomagnetics or from WWW.FTDICHIP.COM. The LM-510 must be configured for the same baud

rate as your virtual com port (See section 4.3 - Setup menu). The baud rate may be set to 9600, 19200, 38400, 57600 or 115200. Factory default is 9600.

GPIB (IEEE-488.2) Interface

The optional LM-510 GPIB interface implements SH1, AH1, T6, L4, SR1, RL0, RL1, PP0, DC1, DT0, C0, and E1 options. The commands are compliant with the IEEE-488.2 standard. The connector is identified on the rear panel of the instrument as the OPTION connector.

Reference: IEEE Standard Codes, Formats, Protocols, and Common Commands (IEEE Std 488.2-1992) provides a detailed description of the IEEE common commands (identifiable in the command list by the asterisk as the first character.)

The command list and structure is identical to the RS-232 command set. IEEE-488.2 device address may be selected from 0 - 31. Factory default is 0.

HTTP Interface

An HTTP interface is provided for the LM-510 to allow simple remote monitoring of sensor readings and allows a new reading to be initiated if a liquid helium channel is being monitored. To use this capability the login "lm510" and password "cmi" should be used.

The HTTP interface is also used to load new firmware updates to the instrument when they are available. To avoid damaging the instrument's operating firmware a different login and password is required. This is provided with the firmware update when it is available.

Command Reference

Commands available over the computer interface are separated into commands that are IEEE 488.2 specific, commands that are inhibited when the operator menu is accessed, and commands that are always available. All command mnemonics that elicit a response from the instrument end with a question (?) character. The general command format is as follows:

<Subcommand1>;<subcommand2>;<subcommand3><RETURN>

where a subcommand is formatted

<Command Mnemonic><SPACE><Parameter>

Example:

*IDN?;CHAN 2;UNITS CM;UNITS?<RETURN>

Semicolons separate responses to each subcommand. The above example would return:

*IDN?;CHAN 2;UNITS CM;UNITS?<RETURN><LINEFEED>

Cryomagnetics,LM-510,2002,2.00;cm<RETURN><LINEFEED>

where the serial number is 2002 and the firmware version number is 2.00.

Error Handling and Command Availability

The ERROR command allows error messages to be enabled or disabled when the USB or RS-232 interface is used. The IEEE-488.2 status mechanisms may always be used to determine if an error occurred processing a command, and the category of the error. Some commands are unavailable if an operator at the instrument is accessing the instrument menu. If a command available only in operate mode is received while the menus are being accessed, a device dependent error is reported in the Extended Status Register (ESR), and the message "Blocked by menu" will be returned if error reporting is enabled when using the RS-232 interface. If commands that are specific to a Liquid Helium Level Sensor are addressed to a Liquid Nitrogen channel, a device dependent error is reported in the ESR, and message "Parameter error" will be returned if error reporting is enabled when using the RS-232 interface.

The following table lists the LM-510 commands, shows the LM-510 mode and channel where the command may be used, and provides a short command description. Command details are provided in the reference that follows.

Command	Available	Description
BOOST	LHe Operate	Set Liquid Helium Level Meter BOOST mode
BOOST?	LHe Operate	Query Liquid Helium Level Meter BOOST mode
CHAN	Operate	Select instrument channel for computer commands
CHAN?	Operate	Query selected channel
CTRL	Operate	Start automated control refill
CTRL?	Always	Query automated control refill status/elapsed fill time
ERROR	Operate	Set error response mode for RS-232 interface
ERROR?	Always	Query error response mode
H-ALM	Operate	Set high alarm threshold
H-ALM?	Operate	Query high alarm threshold
HIGH	Operate	Set high threshold for automated refill completion
HIGH?	Operate	Query high threshold for automated refill completion
INTVL	LHe Operate	Set Liquid Helium Level Meter sample interval
INTVL?	LHe Operate	Query Liquid Helium Level Meter sample interval
L-ALM	Operate	Set low alarm threshold
L-ALM?	Operate	Query low alarm threshold
LNGTH	Operate	Set sensor length
LNGTH?	Operate	Query sensor length
LOCAL	Always	Return control to front panel
LOW	Operate	Set low threshold for automated refill activation
LOW?	Operate	Query low threshold for automated refill activation
MEAS	Operate	Start measurement on selected channel
MEAS?	Operate	Query last completed measurement on selected channel
MODE	LHe Operate	Set Liquid Helium Level Meter sample mode
MODE?	LHe Operate	Query Liquid Helium Level Meter sample mode
REMOTE	Operate	Select remote operation
RWLOCK	Operate	Select remote operation with front panel lock
STAT?	Always	Query instrument status

Command	Available	Description
TYPE?	Operate	Query channel type for selected channel
UNITS	Operate	Select units for selected channel
UNITS?	Operate	Query selected units for selected channel
*CLS	Always	Clear Status Command
*ESE	Always	Standard Event Status Enable Command
*ESE?	Always	Standard Event Status Enable Query
*ESR?	Always	Standard Event Status Register Query
*IDN?	Always	Identification Query
*OPC	Always	Operation Complete Command
*OPC?	Always	Operation Complete Query
*RST	Always	Reset Command
*SRE	Always	Service Request Enable Command
*SRE?	Always	Service Request Enable Query
*STB?	Always	Read Status Byte Query
*TST?	Always	Self-Test Query
*WAI	Operate	Wait-to Continue Command

Command Reference

This section describes how each LM-510 command is used and provides a cross-reference to related commands. The command syntax sections show required elements enclosed in <angle brackets> and optional parameters enclosed in [square brackets]. All numbers are decimal (base 10).

BOOST Set Liquid Helium Level Meter BOOST mode

Availability: Liquid Helium Level Channel in Operate Mode

Command Syntax: BOOST <Boost Mode>

Example: BOOST SMART

Parameter Range: OFF, ON, SMART

Description: The **BOOST** command sets the operating mode for the boost portion of a sensor read cycle. BOOST OFF will eliminate the boost portion of the read cycle, BOOST ON enables the boost portion on every read cycle, and BOOST SMART enables a boost cycle if no readings have been taken in the previous 5 minutes.

Related Commands: BOOST?, CHAN, CHAN?

BOOST? Query Liquid Helium Level Meter BOOST mode

Availability: Liquid Helium Level Channel in Operate Mode

Command Syntax: BOOST?

Response: <Boost Mode>

Response Example: Smart **Response Range:** Off, On, or Smart

Description: The **BOOST?** query returns the operating mode for the boost portion of a sensor read cycle. BOOST OFF will eliminate the boost portion of the read cycle, BOOST ON enables the boost portion on every read cycle, and BOOST SMART enables a boost cycle if no readings have been taken in the previous 5 minutes.

Related Commands: BOOST, CHAN, CHAN?

CHAN Select instrument channel for computer commands

Availability: Operate Mode

Command Syntax: CHAN <Selected Channel>

Example: CHAN 2

Parameter Range: 1 or 2

Description: The CHAN command selects the default channel for future computer commands. The default channel is set to 1 when power is applied or when the *RST command is sent.

Related Commands: BOOST, BOOST?, CHAN?, FILL, FILL?, H-ALM, H-ALM?, HIGH, HIGH?, INTVL, INTVL?, L-ALM, L-ALM?, LNGTH?, LOW, LOW?, MODE, MODE?, MEAS, MEAS?, TYPE?, UNITS, UNITS?, *RST

CHAN? Query selected channel

Availability: Operate Mode

Command Syntax: CHAN?

Response: <Channel number>

Response Example: 1 **Response Range:** 1 or 2

Description: The **CHAN?** query returns the default channel for future computer commands. The default channel is set to 1 when power is applied or when the *RST command is sent.

Related Commands: BOOST, BOOST?, CHAN?, FILL, FILL?, H-ALM, H-ALM?, HIGH, HIGH?, INTVL, INTVL?, L-ALM, L-ALM?, LNGTH?, LOW, LOW?, MODE, MODE?, MEAS, MEAS?, TYPE?, UNITS, UNITS?, *RST

CTRL Activate Control Relay (e.g., automated refill)

Availability: Operate Mode

Command Syntax: CTRL <Control Mode>

Example: CTRL Auto

Default Parameter: Default Channel (See CHAN) **Parameter Range:** 1 to 2

Description: The **CTRL** command sets the control mode of the current channel to the selected mode. The control mode causes the instrument to operate as described in Section 5.2.

Related Commands: CHAN, CHAN?, CTRL?, LOW, LOW?, HIGH, HIGH?, MODE, MODE?, *RST

CTRL? Query automated control (refill) status / elapsed fill time

Availability: Always

Command Syntax: CTRL? [Channel]

Example: CTRL? 2

Default Parameter: Default Channel (See CHAN) **Parameter Range:** 1 to 2

Response: <Mode> or <Refill Time>

Response Examples: Off
15 min
Timeout

Description: The **CTRL?** query returns the status of the Control Relay (i.e., refill status) if the Control Relay is not already active, or the time in minutes since CTRL started if the Control Relay is active. "Off" indicates that a Ctrl Timeout has not occurred. "Timeout" indicates that the Ctrl High limit was not reached before the Timeout time was exceeded, and that Control Relay is inhibited until the operator resets the Ctrl Timeout by selecting MENU on the LM-510 or issuing a *RST command via the computer interface. The Timeout can be inhibited by setting the value to zero in the Ctrl Menu for the channel.

Related Commands: CHAN, CHAN?, CTRL, LOW, LOW?, HIGH, HIGH?, MODE, MODE?, *RST

ERROR Set error response mode for RS-232 interface

Availability: Operate Mode

Command Syntax: ERROR <Error Mode>

Example: ERROR 1

Parameter Range: 0 or 1 (0 - disable error reporting, 1 - enable error reporting)

Description: The **ERROR** command enables or disables error messages when a serial interface is used. It is much easier to handle errors under program control when using a serial interface if error messages are disabled, but it is desirable to enable error messages if a terminal program is used to interactively control and query the LM-510. The last ERROR setting will be retained even when the

instrument is off. It will power up as configured by the last ERROR command.

Related Commands: ERROR?

ERROR? Query error response mode
Availability: Always
Command Syntax: ERROR?
Response: <Error Mode>
Response Example: 0 **Response Range:** 0 or 1
Description: The **ERROR?** query returns the selected error reporting mode.
Related Commands: ERROR

H-ALM Set high alarm threshold
Availability: Operate Mode
Command Syntax: H-ALM [Alarm Level]
Example: H-ALM 65.0
Default Parameter: 100.0 (Off) **Parameter Range:** 0 to Sensor Length
Description: The **H-ALM** command sets the threshold for the high alarm in the present units for the selected channel. If the liquid level rises above the threshold the alarm will be activated. The alarm will be disabled if the threshold is set to 100.0.
Related Commands: H-ALM?, CHAN, CHAN?, LENGTH?, UNITS, UNITS?

H-ALM? Query high alarm threshold
Availability: Operate Mode
Command Syntax: H-ALM?
Response: <Alarm Level> <Units>
Response Example: 15.0 cm **Response Range:** 0 to Sensor Length
Description: The **H-ALM?** query returns the high alarm threshold in the present units for the selected channel.
Related Commands: H_ALM, CHAN, CHAN?, LENGTH?, UNITS, UNITS?

HIGH Set high threshold for the Control functions (automated refill completion)
Availability: Operate Mode
Command Syntax: HIGH [Level]
Example: HIGH 65.0
Default Parameter: 0.0 **Parameter Range:** 0 to Sensor Length
Description: The **HIGH** command sets the high threshold for CTRL functions such as automated

refill completion. The present units for the selected channel are implied. A CTRL (refill) cycle is started when a reading is taken that is below the LOW limit. A CTRL (refill) cycle is completed when a reading is taken that is above the HIGH limit, or when the Ctrl Timeout configured in the CTRL menu is exceeded. A sensor is sampled as in continuous mode during CTRL, but when the HIGH limit is reach the selected sample interval will be used for future readings.

Related Commands: CHAN, CHAN?, CTRL, CTRL?, HIGH?, LNGTH?, LOW, LOW?, MODE, MODE?

HIGH? Query high threshold for Control functions (automated refill completion)

Availability: Operate Mode

Command Syntax: HIGH?

Response: <High Level> <Units>

Response Example: 65.0 cm **Response Range:** 0.0 to Sensor Length

Description: The **HIGH?** query returns the high threshold for Control functions (automated refill completion) in the present units for the selected channel.

Related Commands: CHAN, CHAN?, CTRL, CTRL?, HIGH, LNGTH?, LOW, LOW?

INTVL Set Liquid Helium Level Meter sample interval

Availability: Liquid Helium Level Channel in Operate Mode

Command Syntax: INTVL [Sample Interval ([HH[:MM[:SS]]])]

Example: INTVL 24:00:00

Default Parameter: 0 (Sample Continuously) **Parameter Range:** 00:00:00 to 99:59:59

Description: The **INTVL** command sets the time between samples for the selected Liquid Helium Level Meter channel. Time is in hours, minutes, and seconds.

Related Commands: CHAN, CHAN?, INTVL?

INTVL? Query Liquid Helium Level Meter sample interval

Availability: Liquid Helium Level Channel in Operate Mode

Command Syntax: INTVL?

Response: HH:MM:SS

Response Example: 23:59:59 **Response Range:** 00:00:00 to 99:59:59

Description: The **INTVL?** query returns the time between samples for the selected Liquid Helium Level Meter channel. Time is in hours, minutes, and seconds.

Related Commands: CHAN, CHAN?, INTVL

L-ALM Set low alarm threshold

Availability: Operate Mode

Command Syntax: L-ALM [Alarm Level]

Example: L-ALM 65.0

Default Parameter: 0.0 (Off) **Parameter Range:** 0 to Sensor Length

Description: The **L-ALM** command sets the threshold for the low alarm in the present units for the selected channel. If the liquid level rises above the threshold the alarm will be activated. The alarm will be disabled if the threshold is set to 0.0.

Related Commands: L-ALM?, CHAN, CHAN?, LNGTH?, UNITS, UNITS?

L-ALM? Query low alarm threshold

Availability: Operate Mode

Command Syntax: L-ALM?

Response: <Low Alarm Level> <Units>

Response Example: 15.0 cm **Response Range:** 0 to Sensor Length

Description: The **L-ALM?** query returns the low alarm threshold in the present units for the selected channel.

Related Commands: L_ALM, CHAN, CHAN?, LNGTH?, UNITS, UNITS?

LNGTH? Query sensor length

Availability: Operate Mode

Command Syntax: LNGTH?

Response: <Active Sensor Length> <Units>

Response Example: 120.0 cm **Response Range:** 0.0 to Sensor Length

Description: The **LNGTH?** query returns the active sensor length in the present units for the selected channel. The length is returned in centimeters if *percent* is the present unit selection.

Related Commands: H-ALM, L-ALM, LOW, HIGH, UNITS, UNITS?

LOCAL Return control to front panel

Availability: Always (RS-232 Only)

Command Syntax: LOCAL

Description: The **LOCAL** command returns control the front panel keypad after remote control has been selected by the REMOTE or RWLOCK commands.

Related Commands: REMOTE, RWLOCK

LOW Set low threshold for Control functions (automated refill activation)

Availability: Operate Mode

Command Syntax: LOW [Level]

Example: LOW 45.0

Default Parameter: 0.0 **Parameter Range:** 0 to Sensor Length

Description: The **LOW** command sets the low threshold for Control functions such as automated refill activation. The present units for the selected channel are implied. A CTRL (refill) cycle is started when a reading is taken that is below the LOW limit. The sensor will be sampled in Continuous mode until the HIGH limit is reached. A CTRL cycle is completed when a reading is taken that is above the HIGH limit, or when the Ctrl Timeout configured in the CTRL menu is exceeded.

Related Commands: CHAN, CHAN?, CTRL, CTRL?, HIGH, HIGH?, LNGTH?, LOW?, MODE, MODE?

LOW? Query low threshold for Control functions (automated refill activation)

Availability: Operate Mode

Command Syntax: LOW?

Response: <Low Level> <Units>

Response Example: 45.0 % **Response Range:** 0.0 to Sensor Length

Description: The **LOW?** query returns the low threshold for Control functions such as automated refill activation in the present units for the selected channel.

Related Commands: CHAN, CHAN?, CTRL, CTRL?, HIGH, HIGH?, LNGTH?, LOW

MEAS Start measurement on selected channel

Availability: Operate Mode

Command Syntax: MEAS [Channel #]

Example: MEAS 2

Default Parameter: Default Channel (See CHAN) **Parameter Range:** 1 to 2

Description: The MEAS command starts a measurement on the selected channel. The DATA READY bit for the selected channel will be set in the status byte returned by the *STB? command when the measurement is complete.

Related Commands: CHAN, CHAN?, MEAS?, *STB?

MEAS? Query last completed measurement on selected channel

Availability: Operate Mode

Command Syntax: MEAS? [Channel #]

Example: MEAS? 2

Default Parameter: Default Channel (See CHAN) **Parameter Range:** 1 to 2

Response: <Measured Level> <Units>

Response Example: 15.0 cm

Description: The **MEAS?** query returns latest reading in the present units for the selected channel. If a reading for the selected channel is in progress, the previous reading is returned.

Related Commands: CHAN, CHAN?, MEAS, *STB?

MODE Set Liquid Helium Level Meter sample mode

Availability: Liquid Helium Level Channel in Operate Mode

Command Syntax: MODE <Sample Mode>

Example: MODE S

Default Parameter: 0.0 (Off) **Parameter Range:** S or C

Description: The **MODE** command sets the sample mode for the selected channel. In *Sample/Hold* mode the measurements are taken when a MEAS command is sent via the computer interface, the <Enter> button is pressed on the front panel, or when the delay between samples set by the INTVL command expires. The interval timer is reset on each measurement, regardless of source of the measurement request. In *Continuous* mode measurements are taken as frequently as possible. The channel will also operate as in continuous mode any time a CTRL (refill) cycle has been activated by the level dropping below the LOW threshold until the CTRL cycle is completed by the HIGH threshold being exceeded or a *RST command.

Related Commands: CHAN, CHAN?, CTRL, CTRL?, INTVL, INTVL?, MODE?

MODE? Query Liquid Helium Level Meter sample mode

Availability: Liquid Helium Level Channel in Operate Mode

Command Syntax: MODE?

Response: <Sample Mode>

Response Examples: Sample/Hold

Continuous

OFF

Description: The **MODE?** query returns the sample mode for the previously selected channel. The sample mode may have been set by a MODE command or the front panel menu.

Related Commands: CHAN, CHAN?, INTVL, INTVL?, MODE

REMOTE Select remote operation

Availability: Operate (RS-232 Only)

Command Syntax: REMOTE

Description: The **REMOTE** command takes control of the LM-510 via the remote interface. All

buttons on the front panel are disabled except the Local button. This command will be rejected if the menu system is being accessed via the front panel or if LOCAL has been selected via the Local button on the front panel. Pressing the Local button again when the menu is not selected will allow this command to be executed. This command is only necessary for RS-232 operation since the IEEE-488 RL1 option provides for bus level control of the Remote and Lock controls.

Related Commands: LOCAL, RWLOCK

RWLOCK Select remote operation

Availability: Operate (RS-232 Only)

Command Syntax: RWLOCK

Description: The **RWLOCK** command takes control of the LM-510 via the remote interface. All buttons on the front panel are disabled including the Local button. This command will be rejected if the menu system is being accessed via the front panel or if LOCAL has been selected via the Local button on the front panel. Pressing the Local button again when the menu is not selected will allow this command to be executed. The RWLOCK command is only necessary for RS-232 operation since the IEEE-488 RL1 option provides for bus level control of the Remote and Lock controls.

Related Commands: LOCAL, RWLOCK

STAT? Query instrument detailed status

Availability: Always

Command Syntax: STAT?

Response: <Ch 1 Detailed Status>,<Ch 2 Detailed Status>,<Menu Mode>

Response Example: 8,3,0 **Response Range:** 0,0,0 to 127,127,1

Description: The **STAT?** query returns detailed instrument status as decimal values, and the status of local menu selection. When an operator selects the Menu, the instrument is taken out of operate mode, and <Menu Mode> is returned as 1. <Menu Mode> is returned as 0 when in operate mode. Channel detailed status is returned as a decimal number where each bit indicates a status condition of the channel. The meaning of each bit when set to one is shown:

Channel Detailed Status:

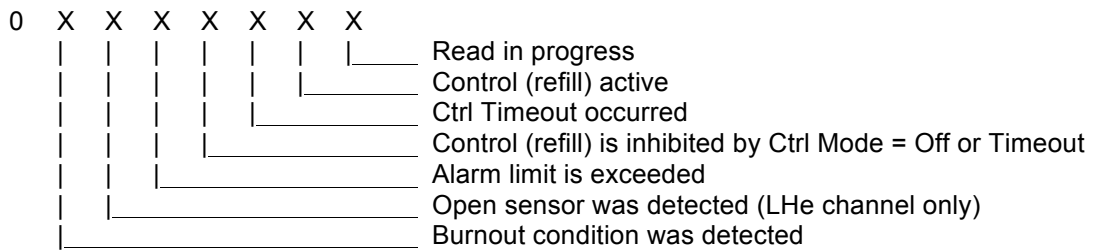

Related Commands: *STB?

TYPE? Query channel type for selected channel
Availability: Operate Mode
Command Syntax: TYPE? [Channel]
Example: TYPE? 2
Default Parameter: <Default Channel> **Parameter Range:** 1 or 2
Response: <Channel Type>
Response Example: 1 **Response Range:** 0 or 1

Description: The **TYPE?** query returns a code for the channel type of the designated channel, or the channel type of the default channel set by the CHAN command if a channel is not specified. 0 denotes a liquid helium level sensor and 1 denotes a liquid nitrogen level sensor.

Related Commands: CHAN, CHAN?

UNITS Select units for selected channel
Availability: Operate Mode
Command Syntax: UNITS <Unit Selection>
Example: UNITS CM
Parameter Range: CM, IN, PERCENT, or %
Description: The **UNITS** command sets the units to be used for all input and display operations for the default channel selected by a prior CHAN command. Units may be set to centimeters, inches, or percentage of sensor length.
Related Commands: H-ALM, H-ALM?, CHAN, CHAN?, HIGH, HIGH?, L-ALM, L-ALM?, LNGTH?, LOW, LOW?, MEAS, MEAS?, UNITS?

UNITS? Query selected units for selected channel
Availability: Operate Mode
Command Syntax: UNITS?

Parameter Range: CM, IN, PERCENT, or %

Response: <Selected Units>

Response Example: cm

Response Range: cm, in, or %

Description: The **UNITS?** command returns the units used for all input and display operations for the default channel selected by a prior CHAN command. Units may be set to centimeters, inches, or percentage of sensor length.

Related Commands: H-ALM, H-ALM?, CHAN, CHAN?, HIGH, HIGH?, L-ALM, L-ALM?, LNGTH?, LOW, LOW?, MEAS, MEAS?, UNITS?

***CLS** Clear Status Command

Availability: Always

Command Syntax: *CLS

Description: The ***CLS** command operates per IEEE Std 488.2-1992 by clearing the Standard Event Status Register (ESR) and resetting the MAV bit in the Status Byte Register (STB).

Related Commands: None

***ESE** Standard Event Status Enable Command

Availability: Always

Command Syntax: *ESE <mask>

Example: *ESE 255

Default Parameter: 0

Parameter Range: 0 to 255

Description: The ***ESE** command operates per IEEE Std 488.2-1992 by setting the specified mask into the Standard Event Status Enable Register (ESE).

Related Commands: *ESE?

***ESE?** Standard Event Status Enable Query

Availability: Always

Command Syntax: *ESE?

Response: <ESE Mask>

Response Example: 255

Response Range: 0 to 255

Description: The ***ESE?** command operates per IEEE Std 488.2-1992 by returning the mask set in the Standard Event Status Enable Register (ESE) by a prior *ESE command.

Related Commands: *ESE

***ESR?** Standard Event Status Register Query

Availability: Always

Command Syntax: *ESR?

Response: <Standard Event Status Register>

Response Example: 128

Response Range: 0 to 255

Description: The *ESR? command operates per IEEE Std 488.2-1992 by returning the contents of the Standard Event Status Register and then clearing the register.

Status Byte Bit Allocations:

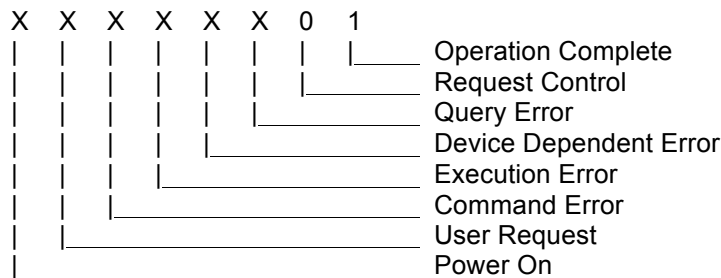

Related Commands: *ESE, *ESE?

***IDN?** Identification Query

Availability: Always

Command Syntax: *IDN?

Response: <Manufacturer>,<Model>,<Serial #>,<Firmware Level>

Response Example: Cryomagnetics,LM-510,2002,2.00

Serial # Range: 2000 to 9999

Firmware Level Range: 1.00 to 9.99

Description: The *IDN? command operates per IEEE Std 488.2-1992 by returning the LM-510 manufacturer, model, serial number and firmware level.

Related Commands: None

***OPC** Operation Complete Command

Availability: Always

Command Syntax: *OPC

Description: The *OPC command operates per IEEE Std 488.2-1992 by placing the Operation Complete message in the Standard Event Status Register (ESR). The LM-510 processes each command as it is received and does not defer any commands for later processing.

Related Commands: *OPC?

***OPC?** Operation Complete Query

Availability: Always

Command Syntax: *OPC?

Description: The ***OPC** command operates per IEEE Std 488.2-1992 by placing an ASCII character "1" in the output queue since the LM-510 does not defer any commands for later processing.

Related Commands: *OPC

***RST** Reset Command

Availability: Always

Command Syntax: *RST [hw]

Default Parameter: blank **Parameter Range:** blank or hw

Description: The ***RST** command operates per IEEE Std 488.2-1992 by returning the LM-510 to its power up configuration. This selects channel 1 as the default channel, terminates any control (refill) sequence in progress, and clears any Ctrl Timeouts that may have occurred. If the optional parameter <hw> is provided, the instrument will perform a hardware reset one second later instead of returning to power up configuration as required by the Standard.

Related Commands: None

***SRE** Service Request Enable Command

Availability: Always

Command Syntax: *SRE <mask>

Example: *SRE 255

Default Parameter: 0 **Parameter Range:** 0 to 255

Description: The ***SRE** command operates per IEEE Std 488.2-1992 by setting the specified mask into the Service Request Enable Register (SRE).

Related Commands: *SRE?

***SRE?** Service Request Enable Query

Availability: Always

Command Syntax: *SRE?

Response: <SRE Mask>

Response Example: 255 **Response Range:** 0 to 255

Description: The ***SRE?** command operates per IEEE Std 488.2-1992 by returning the mask set in the Service Request Enable Register (SRE) by a prior *SRE command.

Related Commands: *SRE

***STB?** Read Status Byte Query

Availability: Always

Command Syntax: *STB?

Response: <Status Byte>

Response Example: 65

Response Range: 0 to 255

Description: The *STB? command operates per IEEE Std 488.2-1992 by returning the Status Byte.

Status Byte Bit Allocations:

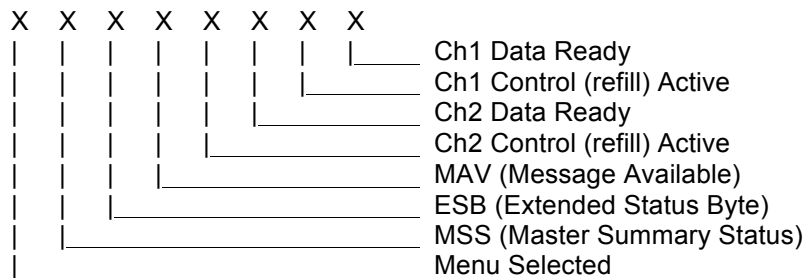

*** TST?** Self-Test Query

Availability: Always

Command Syntax: *TST?

Response: <Self test status>

Response Example: 1

Response Range: 1

Description: The *TST? command operates per IEEE Std 488.2-1992 by returning the self-test status. Explicit tests are not performed in response to this command, but a 1 is returned for compliance with the specification.

Related Commands: None

*** WAI** Wait-to-Continue Command

Availability: Always

Command Syntax: *WAI

Description: The *WAI? command operates per IEEE Std 488.2-1992 by accepting the command without generating an error. Since the LM-510 only implements sequential commands the no-operation-pending flag is always TRUE.

Related Commands: OPC, *OPC?

Appendix B

Line Voltage Controller Module – Option 4

Overview

The Line Voltage Controller Module enables the LM-510 to control one or two 115/230 VAC loads up to 1 Amp each using the LM-510 Low and High setpoints. Section 5.5, Automatic Refill, describes operation of the LM-510 in automatic refill applications. The outputs are labeled channel 1 and channel 2, and are controlled by the respective channels of the LM-510.

Connections

An interconnection cable is provided with the Line Voltage Controller Module to connect the LM-510 to the Line Voltage Controller Module and to the sensors. The DB-15M connector attaches to the LM-510, the DB-9F attaches to the Line Voltage Controller Output Module. Individual sensor connectors on the cable for channel 1 and channel 2 are labeled. Output connections are standard 115V or 230V output sockets as specified per order.

DB-9M Pinout

Pin 1 - Channel 1 control input (0V - enabled, open - disabled)

Pin 3 - Channel 2 control input (0V - enabled, open - disabled)

Pin 6 - +15V input (10 ma max)

Pin 9 - Ground

Fuses

Each output is individually fused on the rear panel of the module with a user replaceable 2 amp 250VAC fuse. Slow blow fuses should not be used.

Theory of Operation

The 'hot' side of each output is individually switched using an opto-isolated solid state switch rated for 20-500Hz operation. These switches exhibit a 1 mA off-state leakage current, which will be observed as 90-100 VAC if the output is checked with a voltmeter with no load attached to the output.

Appendix C

Factory Calibration / Firmware Updates

Overview

The LM-510 is initialized and fully calibrated at the factory prior to delivery to establish sensor excitation levels, to calibrate hardware (such as analog outputs), and in the case of an LN2 channel, to calibrate smart sensors. Recalibration should not be necessary. If you believe your LM-510 requires recalibration, contact Cryomagnetix for assistance.

***** WARNING *****

Excitation voltages for LHe sensors can be dangerous.

Proper care must be exercised to ensure safety of personnel and equipment.

Load resistors and/or sensors must be attached to perform the calibration in most cases.

Power MUST be removed while making ALL connections.

Liquid Helium Channels

Verification of factory calibration of a liquid helium channel requires a known calibration resistor to be connected. LHe level sensors typically have a normal resistance of about 4.5 ohms per cm, may be up to 200 cm long, and are excited with a constant current of 70 mA. This means voltages at the output of the LM-510 may be as high as ~70V DC. The power capacity of the calibration resistor must also be considered. Do not attempt to perform a factory calibration without the assistance of a trained Cryomagnetix technician.

Liquid Nitrogen Channels

Factory calibration of a liquid nitrogen channel requires the sensor to be connected and operated in known levels of liquid nitrogen. The LN2 level used to calibrate the sensor should be measured carefully to avoid errors. Preferably, the level should be at or near the top of the sensor. Contact Cryomagnetix for information on calibration of Smart LN2 sensors.

Firmware Updates

Firmware updates for the LM-510 may be installed without returning the unit to the factory. The procedure involves downloading a firmware upgrade file from the Cryomagnetics website and then transferring the software to the LM-510 through the Ethernet port of the instrument. Contact Cryomagnetics for information and instructions on upgrading the firmware of your LM-510.